

DROP FORK LATCH

CLAMP A

- 1 3/8"
- 1 5/8"
- 2"

FORK B

- 1 3/8"
- 2"
- 2 3/8"
- 3"
- 4"

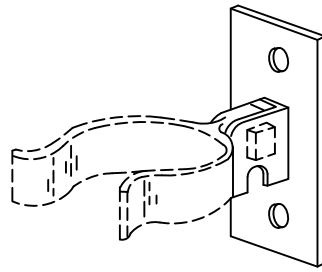

DROP FORK BRACKET

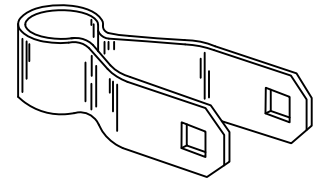

DROP ROD GUIDE

1 3/8"

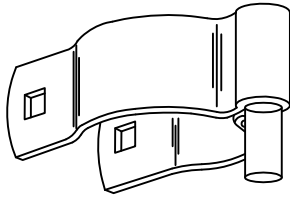

MALE HINGE

- 1" WIDE
- 1 3/8"
- 1 5/8"
- 2"
- 2 1/2"
- 1-1/2" WIDE
- 3"

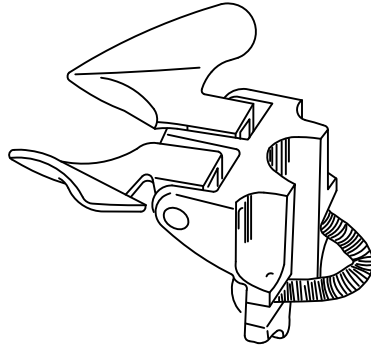

BUTTERFLY FORK LATCH

- 2"
- 2 1/2"

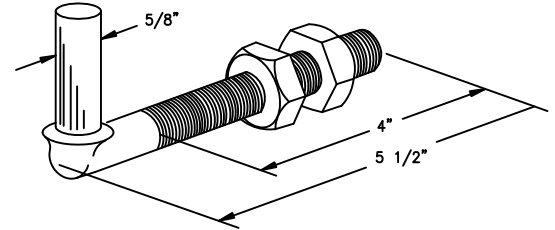

J-BOLT - MALE HINGE WITH TWO BOLTS

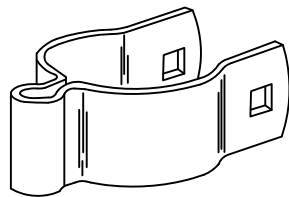

FEMALE HINGE

- 1 3/8"
- 1 5/8"
- 2"

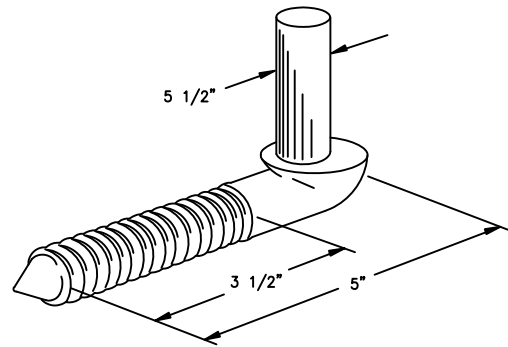

LAG SCREW - MALE HINGE WITH SHOULDER



Drawn by: Brown, C	FENCE SUPPLY INC. <a href="http://www.fencesupplyinc.com">www.fencesupplyinc.com</a>	
Checked by: Wingo, C	437 E. HWY 80 SUNNYVALE, TEXAS 75182	
Date: October 30, 2008	Description: Chainlink Gate Hardware Parts	
Customer:	DWG. NO:   of	SERIES: Chainlink
	APPLICATION: Residential/ Commercial/ Industrial	